

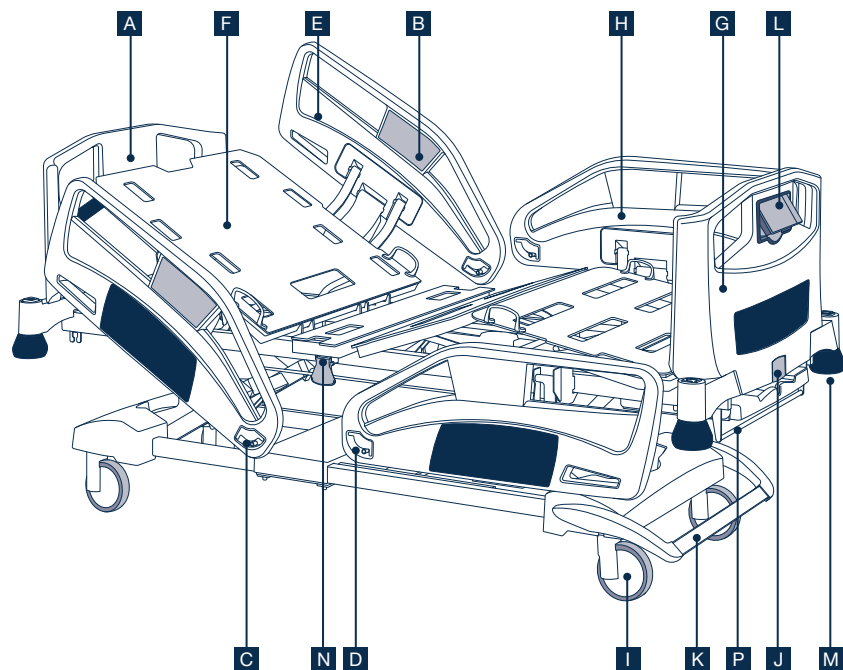

NewCare V3 ACT Bed

QUICK REFERENCE SHEET



BED'S COMPONENTS

A	Removable headboard	I	Integral wheels Ø15 cm.
B	Membrane control in side rails	J	Headboard and footboard unlocking
C	Backrest tilting indicator	K	Braking pedal
D	Trend / Reverse Trend tilting indicator	L	Touch screen
E	Backrest side rails	M	Protection discs
F	HPL mattress platform	N	Emergency CPR
G	Removable footboard	P	Extended bed base
H	Legrest side rails		

OTHER FUNCTIONS

Side Rails (1):

- Raising the rail: Pull the rail upwards until it is immobilised in the highest position.
- Lowering the rail: Pull the handle found underneath the rail outwards. The rail will automatically lower.

Braking pedal (3):

- Braking the bed: Pedal in low position.
- Moving the bed: Pedal in intermediate position.
- Activating 5th or steering wheel: Pedal in raised position.

Emergency CPR (2):

- Activate either of the two levers located in the middle of bed base, accompanying it in turn as it lowers.

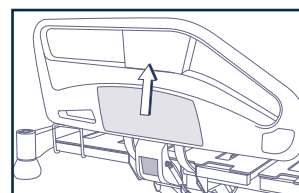

Raising the rails

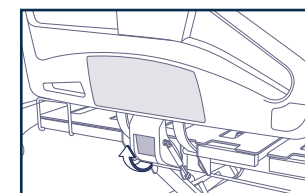

Lowering the rails

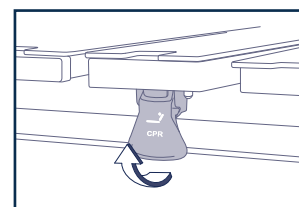
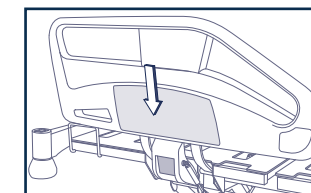

Emergency CPR

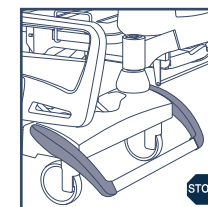

Brake

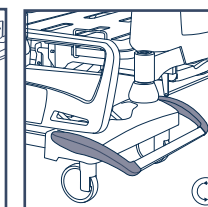

Free movement

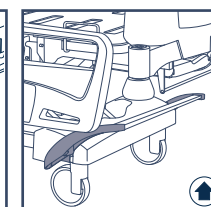

Steering or 5th wheel

CLEANING

Daily cleaning and disinfection with soapy water:

- Rails. Head board. Foot board.

Cleaning and disinfection after a patient leaves or before a transfer:

- Mattress platform area. Chassis of the bed.

Thorough cleaning and disinfection every two months:

- Support and lifting area of the bed.

MAINTENANCE

Always check the correct state of:

- Electrical wiring
- Wheels.
- Braking mechanisms.

www.pardo.es

TECHNICAL SERVICE CENTRE

(+34) 976 300 033

For more information, please consult the use and maintenance manual.



INSTRUCTIONS OF USE -
TOUCH SCREEN

1	Function selection (basic movements)
2	Options selection (weighing)
3	Adjustment selection
A	Rise backrest
B	Lower backrest
E	Rise legrest
F	Lower legrest
I	Rise mattress platform
J	Lower mattress platform
K	Locking movements
N	Cardiac chair position
P	Emergency CPR
Q	On/Off Button (active screen)
R	Matress platform selection
S	Rise simultaneously sections selection
V	Trend / Reverse Trend selection
X	Explorer position (maximum height)

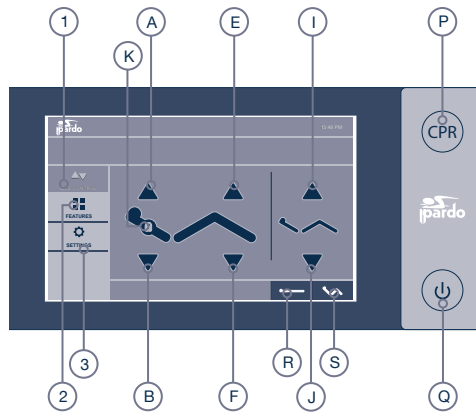

Touch screen - Basic Menu

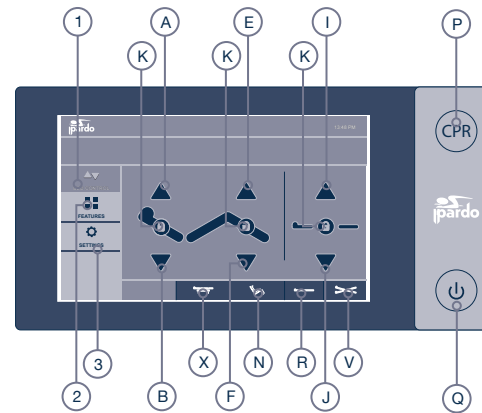

Touch screen - Nursing Menu

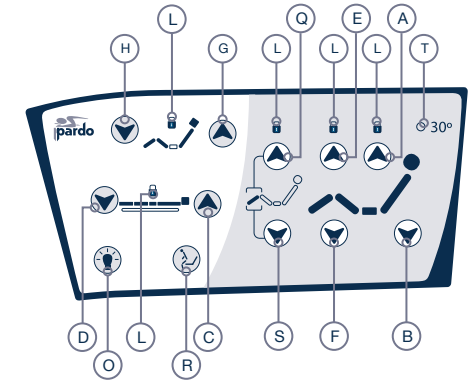

Patient control for motorised foot section

INSTRUCTIONS OF USE - MEMBRANES

A	Rise backrest	K	Locking movements
B	Lower backrest	L	Indicator Led of locked movements
C	Rise mattress platform	N	Cardiac chair position
D	Lower mattress platform	O	Light under bed
E	Rise legrest	P	Emergency CPR
F	Lower legrest	R	Safe bed exit position
G	Rise all sections simultaneously (<i>autocontour</i>)	T	Led indicator for 30° tilting backrest
H	Lower all sections simultaneously (<i>autocontour</i>)	U	Led indicator for low position
I	Reverse Trend	Q	Rise foot section
J	Trend	S	Lower foot section

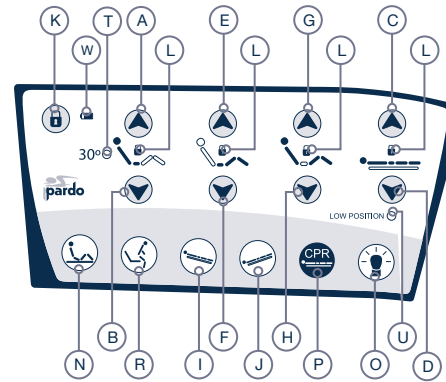

Nursing membrane with locking

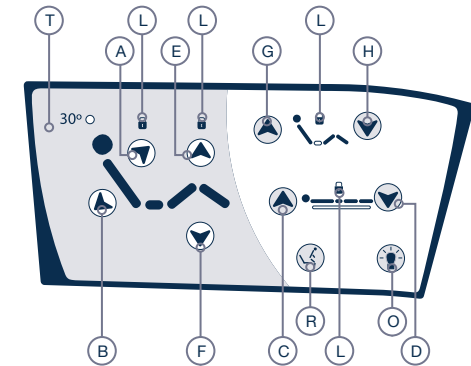

Patient membrane with locking



SAFETY WARNINGS

- The maximum duration of a continuous manoeuvre should not exceed 2 minutes, as damage may be caused to the equipment.
- Before raising and lowering the moving parts of the mattress platform, with the other parts of the bed or accessories, it is essential to check that there are no obstacles between them.
- The Trendelenburg and reverse Trendelenburg movement should always be performed under medical supervision.
- When the bed is in extended position, do not sit or lean on the foot part of the bed, since it may cause a bed dump.
- Do not use CPR bilateral actuating levers to raise the backrest of the bed, it may cause raise motor breakdown and makes a bed dysfunction.

