

## Features

Complete electric and articulated ICU bed; easy and friendly use, it is seeking welfare and patient comfortability.

Some of its main characteristics are:

- To transport easier:

Lightweight. It has four castors with high rolling, wear and rust resistance. It has a minimum noise emission whilst moving;

It has a centralised braking system by a steering bar, located under the footboard.

The central locking system has three levels: all casters locked, unlocked 360° rolling casters and steering directional caster.

- Easy and intuitive using:

Touch screen on the footboard is the principal control to move the bed. Furthermore this screen controls the bed's weighing system.

Depending on the bed options, the bed can have a membranes with function blocking and pre-programmed functions for the nursing staff in the side rails.

RCP bilateral actioning system, placed in both sides of the bed at the middle section, independently the position of side rails.

- Encourage the welfare of patient:

The backrest section is X-ray transparent, ready to use with X-Ray.

Extended bed base until 30 cm, one-handed operation.

Double-regression system (16'5 cm), this system minimize the pressure in the sacrum zone of patient to reduce the risk of pressure ulcers.

Articulated footrest section in different positions by gas spring system.

New pre-programmed positions to ensure the patient welfare (safe exit, 30° backrest, etc).

- Other advantages:

HPL bed base divided in 4 sections. Removable all of them without tools, except the central section, which is fixed.

All of components of bed are easy to clean and have a high antibacterial protection.

Polypropylene side rails with hand grip zone to help the patient sitting and exit the bed. Folding system by gas spring.

Easily removable head and foot boards one-handed, with locking system.

Linear actuators with IPX6 protection.

4 protection cylinders localised in the corners that avoid the shocks reducing the impacts and damage of bed..

2 guides localise on both sides of bed to hang up drain hooks. There are include four drain hooks on each guide.

4 mattress retainers in feet and thorax.

Customizable vinyls.

Weight capacity for the weight scale system: 265 kg.

- Furthermore the NewCare V3 ACT bed disposes of a wide range of accessories and complements, which provide to comply the hospital and patient needs for their comfort and welfare.



# NewCare V3 ACT ICU Bed









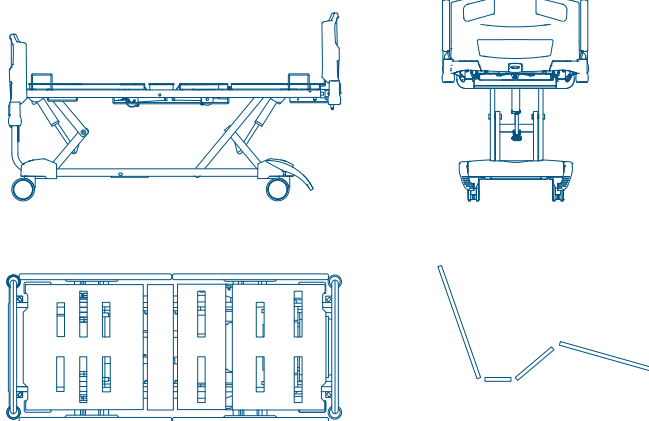

## Technical information





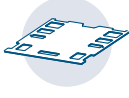

Total length with headboard and footboard	222 cm ± 1 cm.
Total width with side rails	101 cm ± 1 cm.
Minimum / maximum height of bed base (without mattress)	
<ul style="list-style-type: none"> <li>Integral wheel (Ø15 cm)</li> <li>Double wheel (Ø15 cm)</li> </ul>	42'5 / 84 cm ± 1 cm. 41'5 / 83 cm ± 1 cm.
Crane passing clearance height	
<ul style="list-style-type: none"> <li>Integral wheel (Ø15 cm)</li> <li>Double wheel (Ø15 cm)</li> </ul>	18'5 cm ± 1 cm. 17'5 cm ± 1 cm.
Length of extended bed base	30 cm.
Wheels diameter	15 cm.
Width of bed base	83 cm.
Length of bed base sections	74'4 / 16'5 / 32 / 61'5 cm.
Angle of backrest tilting	65° ± 5°
Angle of legrest tilting	45° ± 2°
Angle of footrest tilting	18° / 7° ± 2°
Bed base double-regression	16'5 cm ± 1 cm.
Angle of trend / reverse trend tilting	17° / 17° ± 2°
Maximum patient weight (MPW)	205 kg.
Safe working load (SWL)	265 kg.
Unladen bed weight	From 140 kg. to 160 kg.
Recommended dimensions of mattress*	85 x 200 cm.

\*The mattress for this kind of bed has four cut corners.

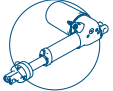

## Configuration

Standard			
Protection	Transport	Wellness	Others
			
Split side rails	Integral wheel (Ø15 cm)	Spring gas for foot section	Pardo P.7461 Vinyl
			
Removable headboard	Centralised brake	HPL bed base	Drain hooks
			
			Weighing system on the touch screen

Opcional			
Protección	Transporte	Bienestar	Otros
			
Safe bed exit side rails for backrest	Double wheel (Ø15 cm)	Table under footboard	Braking alarm
			
		Motorised foot section	Battery
			
			Light under bed
			
			Nursing call button
			
			Customizable vinyl

 Mandatory standards  
 Changeable options

## Control remote configuration

Mandatory controls in all the beds



Touch screen

Mandatory controls on the side rails

Standard versions

Exclusive version for motorised foot section



Nursing membrane with lockings



Patient membrane with lockings



Nursing membrane

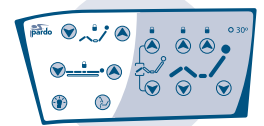

Patient membrane

Optional controls

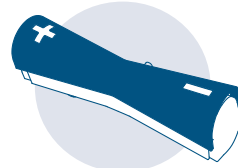

Lifting pedal

## Electrical information

Lifting bed system	2 Linear motors
Tilting backrest system	Linear motor
Tilting legrest system	Linear motor
Voltage and frequency	100 V - 240 V
Electrical shock protection / penetration liquid	Class I / Type B / IPX6
Maximum consumption	200 W
Intermittent operation of actuator	10% 2 min. - 18 min.

## Accessories



IV-Pole with 2 hooks



IV-Pole with 4 hooks



Techno trapeze bar

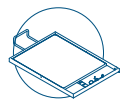

X-ray cassette tray

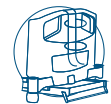

Tank holder



Balkan frame



Multifunction table

## Standards

- UNE EN ISO 12100 Standard
- UNE EN 60529 Standard
- UNE EN 60204-1 Standard
- UNE EN 60601-1 Standard
- UNE EN 60601-1-2 Standard
- UNE EN 60601-2-52 Standard
- UNE EN 45501-16 Standard

## EN 60601-2-52:2010 tests

- Electrical and Electromagnetic test made in ITA (Instituto tecnológico de Aragón).
- Mechanical test of side rails made in IBV (Instituto Biomecánico de Valencia).