

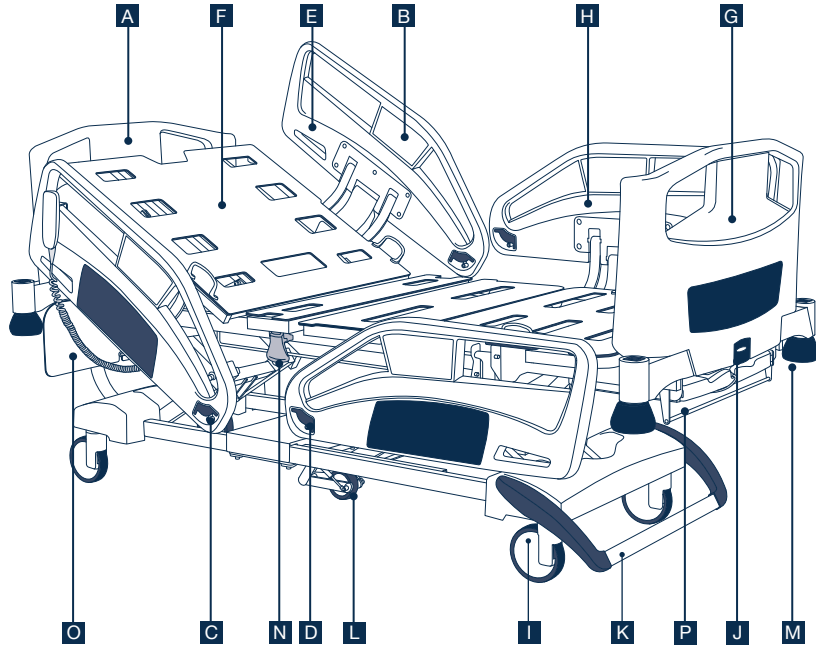

NewCare V3 Bed

QUICK REFERENCE SHEET



BED'S COMPONENTS

A	Removable headboard	I	Wheels Ø15 cm.
B	Side rails membrane control	J	Headboard and footboard unlocking
C	Backrest tilting indicator	K	Braking pedal
D	Trend / Reverse Trend tilting indicator	L	5 th wheel
E	Backrest side rails	M	Protection discs
F	HPL mattress platform	N	Emergency CPR
G	Removable footboard	O	Anchored headboard
H	Legrest side rails	P	Extension bed base

OTHER FUNCTIONS

Side Rails (1):

- Raising the rail: Pull the rail upwards until it is immobilised in the highest position.
- Lowering the rail: Pull the handle found underneath the rail outwards. The rail will automatically lower.

Braking pedal (3):

- Braking the bed: Pedal in low position.
- Moving the bed: Pedal in intermediate position.
- Activating 5th or steering wheel: Pedal in raised position.

Emergency CPR (2):

- Activate either of the two levers located in the middle of bed base, accompanying it in turn as it lowers.

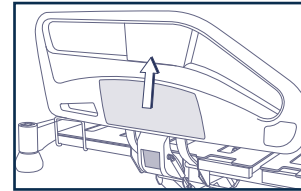

Raising the rails

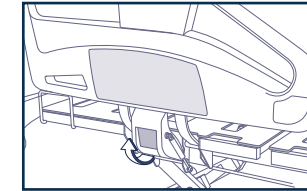

Lowering the rails

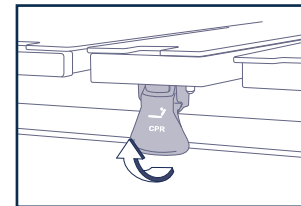
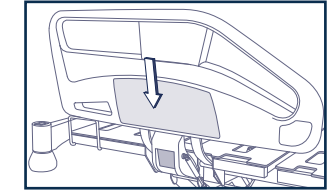

Emergency CPR

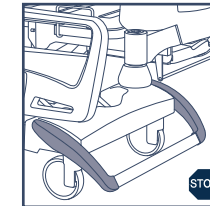

Brake

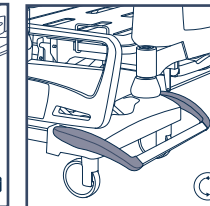

Free movement

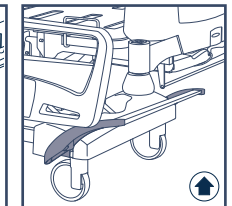

Steering or 5th wheel

CLEANING

Daily cleaning and disinfection with at least 1000ppm concentration of chlorine solutions:

- Rails. Head board. Foot board.

Cleaning and disinfection after a patient leaves or before a transfer:

- Mattress platform area. Chassis of the bed.

Thorough cleaning and disinfection every two months:

- Support and lifting area of the bed.

MAINTENANCE

Always check the correct state of:

- Electrical wiring
- Wheels.
- Braking mechanisms.

www.pardo.es

TECHNICAL SERVICE CENTRE

(+34) 976 300 033



For more information, please consult the use and maintenance manual.

CONTROLS

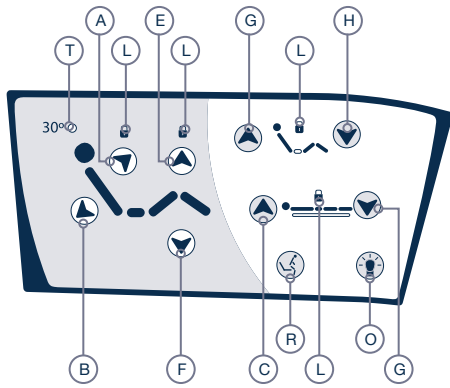

Patient membrane with locking

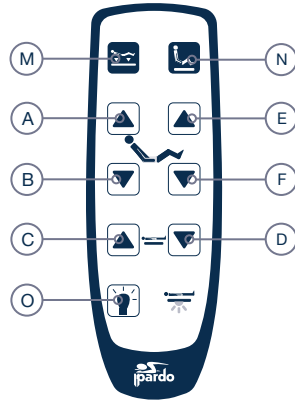

Patient hand control with light

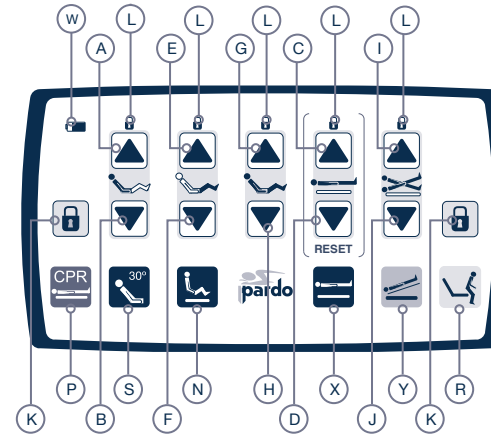

Nursing hand control

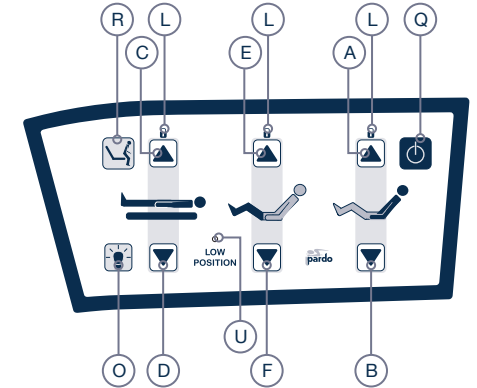

Membrane side rails

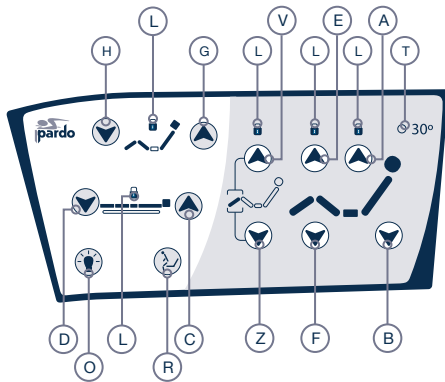

Patient control for motorised foot section

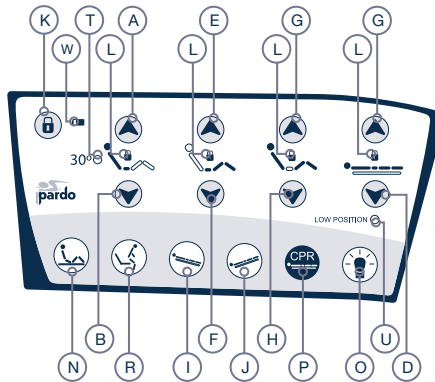

Nursing membrane with locking

INSTRUCTIONS OF USE

A	Rise backrest	N	Cardiac chair position
B	Lower backrest	O	Light under bed
C	Rise mattress platform	P	Emergency CPR
D	Lower mattress platform	Q	On/Off Button (to active membranes)
E	Rise legrest	R	Safe bed exit position
F	Lower legrest	S	30° tilting backrest position
G	Rise all sections simultaneously (<i>autocontour</i>)	T	30° tilting backrest Led indicator
H	Lower all sections simultaneously (<i>autocontour</i>)	U	Low position Led indicator
I	Reverse Trend	V	Rise foot section
J	Trend	W	Battery indicator
K	Locking movements	X	Explorer position (maximum height)
L	Indicator Led of locked movements	Y	Emergency trend position
M	Flat Position (lower all sections simultaneously)	Z	Lower foot section



SAFETY WARNINGS

- The maximum duration of a continuous manoeuvre should not exceed 2 minutes, as damage may be caused to the equipment.
- Before raising and lowering the moving parts of the mattress platform, with the other parts of the bed or accessories, it is essential to check that there are no obstacles between them.
- The Trendelenburg and reverse Trendelenburg movement should always be performed under medical supervision.
- When the bed is in extended position, do not sit or lean on the foot part of the bed, since it may cause a bed dump.
- Do not use CPR bilateral actuating levers to raise the backrest of the bed, it may cause raise motor breakdown and makes a bed dysfunction.

